



Theatrical Supplies of Australia
 6 Columbia Crt, Dandenong Sth, VIC 3166
 Ph: 03 9564 3530
 tsa@theatricalsupplies.com.au

HEAVY DUTY STAGE TRACK

The TSA heavy duty extruded aluminium curtain track is suitable for use in schools, theatres, and many other commercial applications.

The track is designed to cater for large and/or heavy drapes.

It can be fitted directly to overhead soffit fixings, or secured by a variety of available track hanging brackets.

Features

- Anodised black matt finish
- Wide variety of accessories
- Can be curved
- No welding required
- Light weight (1.62 kg/m)
- Can be fixed at 2.0–2.5 m centres

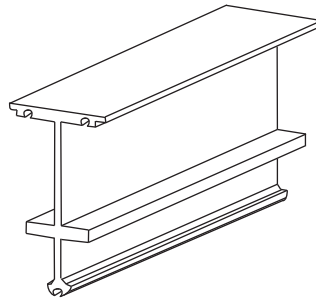

HEAVY DUTY STAGE TRACK
360 track hd

TECHNICAL DATA

Weight : 1.578 kg/m
 Material : Aluminium
 Finish : Black anodised
 Standard length: 5.8 mts

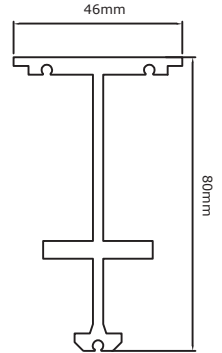

TRACK SECTION



**90 DEGREE TRACK BEND
800mm RADIUS**
360 hd 8b

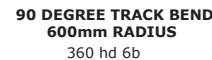

**90 DEGREE TRACK BEND
600mm RADIUS**
360 hd 6b

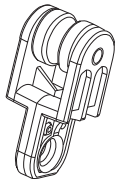

NYLON RUNNER
362 runner

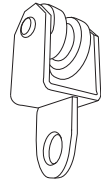

METAL RUNNER
362 steel-runner-w

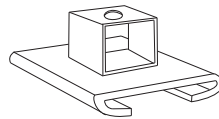

HANGING BRACKET BLOCK
363 hbracket block

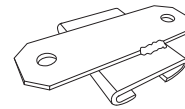

HANGING BRACKET-CEILING FIX
363 hbracket topfix

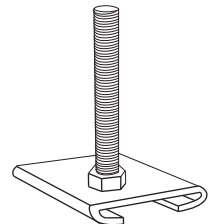

HANGING BRACKET M10
363 hbracket thr

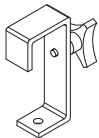

HOOK CLAMP -M10 hole
363 hclamp-m10

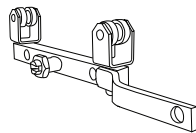

MASTER CARRIER-cranked
365 crledr

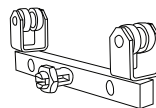

MASTER CARRIER-straight
365 st-pivot



WEIGHTED FLOOR PULLEY
367 w8t puly

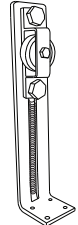

**SPRING LOADED PULLEY
FLOOR MOUNTED**
367 ajs puly

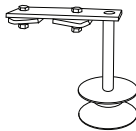

LIVE PULLEY
367 lv puly



DEAD PULLEY
367 dd puly

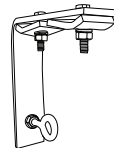

ROPE GUIDE
364 pickup lb

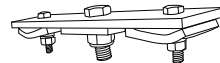

TRACK SPACER CLAMP
368 trk cl

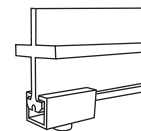

TRACK END STOP
368 end-stop

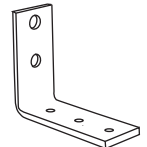

L- BRACKET
170mm x 170mm
304 LB 170

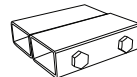

SINGLE PULLEY PACKER
368 trk pkr

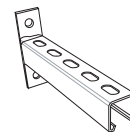

WALL BRACKET - 250mm
304 WB 250

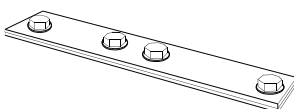

JOINING PLATES
366 jplate
(Includes 3 joining pins)

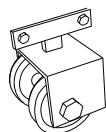

END PULLEY-DOUBLE
367 dbl puly

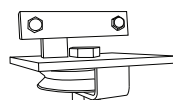

END PULLEY-SINGLE
367 sgl puly

Also available
WALL- BRACKET - 350mm
304 WB 350

125mm x 125mm
304 LB 125R

100mm x 110mm
304 LB 100